



DC30D GENSET CONTROLLER USER MANUAL



Software Version

No.	Version	Date	Note
1	V1.0	2018-9-1	Original release.
2	V1.1	2020-6-2	One phase / three phase automatic judgment function is added to the generator phase number.
3	V1.2	2020-8-1	1. Add "Fuel output delay" setting function; 2. Configurable relay output to increase "Rated running" 3. Add the setting option of "ATS in manual mode"; 4. Add some oil level sensor curves.
4	V1.3	2021-1-21	1. Name of unified input and output port. 2. Correction of errors in wiring diagram. 3. The disconnection action of oil pressure and temperature sensor changes from warning to alarm.
5	V1.4	2021-12-01	1. Update product pictures and icons to the latest version.

Symbol Description

Symbol	Description
 Note	Remind operators to operate correctly, otherwise it may cause the equipment not to work correctly.
 Be care	It is indicated that potential hazards can damage equipment without proper precautions.
 Warning	It is indicated if appropriate preventive measures are not taken, potentially dangerous situations may result in death, serious personal injury or significant property losses.



Chongqing Mebay Technology Co.,Ltd

Add: No6-2,Building 4, Gangan Rd, Jiangbei District, Chongqing.

Tel: +86-23-6869 3061

Fax: +86-23-6765 8207

Web: <http://www.mebay.cn>

<http://www.cqmb.cn>

E_mail: sales@mebay.cn

Warning

- 1.The installation of this equipment must be carried out by professionals.
- 2.When installing and operating the controller, please read the entire instruction manual first.
- 3.Any maintenance and commissioning of the equipment must be familiar with all the equipmen
- 4.t, safety standards and precautions in advance, otherwise it may cause personal injury or damage to related equipment.
- 5.The engine must have an overspeed protection device independent of the controller system to avoid casualties or other damage caused by engine out of control.
- 6.After the installation of the controller is completed, please verify that all protection functions are valid.

Be Care

- 1.Please keep the good connection of the power supply of the controller. Do not share the connection lines of the positive and negative electrodes of the battery with the floating charger.
- 2.During the operation of the engine, do not disconnect the battery,otherwise it may cause damage to the controller.

Catalogue

1. Summary.....	5
2. Main Features.....	5
3. Parameters Display.....	5
4. Protection.....	6
5. Parameters.....	6
6. Overall Dimension and Wiring Diagram.....	7
7. Installation instruction.....	10
9. Parameter setting.....	19
10. Fault finding.....	27

Notes:

1. All rights reserved. No part of this duplication may be reproduced in any material form(including photocopying or storing in any medium by electronic means or others) without the written permission of the copyright holder.
2. MEBAY Technology reserves the rights to change the contents of this document without prior notice.

1. Summary

This Controller Series is specialized for small diesel, gasoline, gas generator sets' start, stop, monitor and defaults checking as well as parameters setting.

The controller has a point array LCD screen, can display various faults in the same time that the genset will be stopped once it can not work smoothly.

There are Chinese/English interface options, more language can be set according to user's request. All the parameters can be configured through the front face buttons or use programmable interface by USB to adjust via PC. It can be widely applied for all kinds of auto control system of gensets.

2. Main Features

- ◆ 32 units Micro-processor technology is used.
- ◆ 1.8 inches 128*64 LCD display with backlight, option language interface (Chinese/English), user's language set if necessary.
- ◆ PC front face panel, which is water-proof, oil-proof, UV proof so that the durability is longer.
- ◆ USB Port: parameters can be set even without power.
- ◆ All the parameters can be set through front panel buttons.
- ◆ Collect and display a variety of engine and generator parameters.
- ◆ Records function: relative faults shall be recorded in real time.
- ◆ It has 5 relay outputs, 3 of which are configurable, and more than 10 functions can be selected for each channel.
- ◆ 1 switch value input, and each can be set as max 20 functions.
- ◆ 3 sensor simulation input connectors, various kinds of units can be set.
- ◆ Sensor can be self-defined by front face button or PC software.
- ◆ Various of crank conditions (RPM, Frequency, Oil Pressure) can be chosen
- ◆ Control Protection: Auto Start/Stop of genset, load transfer and perfect failure display and protection.
- ◆ Standard water-proof rubber gasket. The waterproof can reach IP54.
- ◆ Module design: All the connections are adapted with European connectors so that installation, connection, repair and replacement can be more easily.

3. Parameters Display

- ◆ Engine RPM
- ◆ Engine oil pressure
- ◆ Engine temperature
- ◆ Engine fuel level
- ◆ Engine battery voltage
- ◆ Generator voltage L-N
- ◆ Generator current A

- ◆ Generator Frequency Hz
- ◆ Generator active power KW
- ◆ Successful start Times
- ◆ Current running time
- ◆ Total running time
- ◆ Classes maintenance notice

4. Protection

- ◆ Over speed
- ◆ Under speed
- ◆ Low oil pressure
- ◆ High temperature
- ◆ Low fuel level
- ◆ External emergency alarm
- ◆ Sensor Open
- ◆ Over Frequency
- ◆ Under Frequency
- ◆ Over voltage
- ◆ Under voltage
- ◆ Over current
- ◆ Maintenance expire
- ◆ Low water level alarm
- ◆ Emergency Stop
- ◆ Crank failure
- ◆ Stop Failure
- ◆ Over battery voltage
- ◆ Under Battery voltage

5. Parameters

Options	Parameters
Operation Voltage	DC8-36V Continuous
Power Consumption	Standby: 24V: MAX 1W
	Working: 24V: MAX 2W
AC Voltage Input	1P2W(L-N input) 30VAC-360VAC(ph-N)
Rotate speed sensor Frequency	50-9000Hz
Generator Frequency input	50/60Hz
MAX Accumulating Time	9999.9Hours (Min Store time:6min)
Fuel Relay Output	1Amp DC+VE Supply voltage
Start Relay Output	1Amp DC+VE Supply voltage
Programmable Relay output 1	1Amp DC+VE Supply voltage

Programmable Relay output 2	1AMP Non-contact-Normal open--Normal close output
Programmable Relay output 3	1AMP Non-contact Normal Open output
Switch value input	Available if connecting with Battery -
Insulation strength	Apply AC1.5kV voltage between high voltage terminal and low voltage terminal; The leakage current is not more than 3mA within 1min.
Working condition	-25-65℃
Storage condition	-40-85℃
Protection Level	IP54: when waterproof rubber gasket is added between controller and its panel
Overall dimension	106mm×86mm×45mm
Panel cutout	78mm×66mm
Weight	0.25Kg

6. Overall Dimension and Wiring Diagram

◆ Overall Dimension:

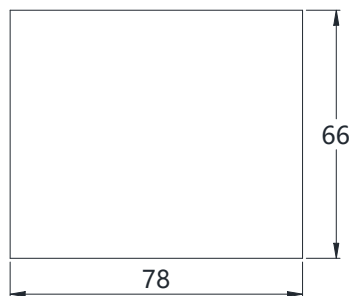
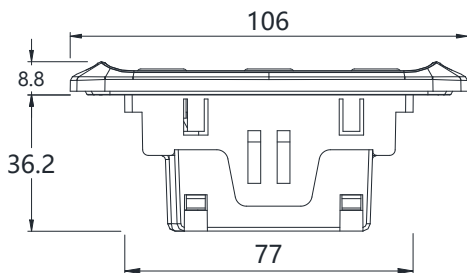
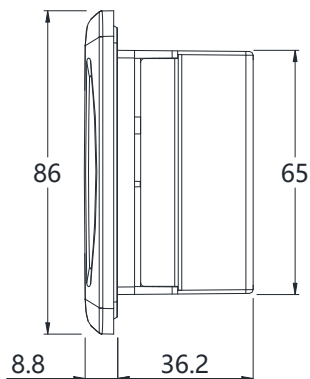
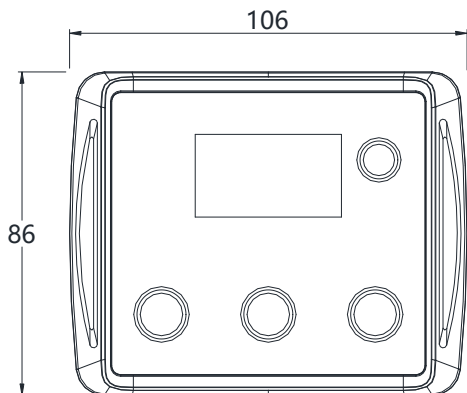

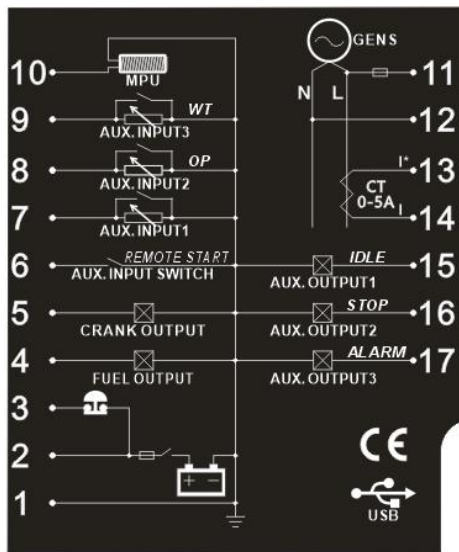
◆ Descriptions of terminal connection

No.	Function	Description	Cable cross sectional area
1	Battery Negative Input B-	Controller power supply input B-.	1.5mm ²
2	Battery Negative Input B+	Controller power supply input B+.	1.5mm ²
3	Emergency Stop Input	B+ voltage input is active, and connected to emergency stop normal closed button.	1.0mm ²
4	Fuel Output	Rated current 1A; power supplied by PIN 2.	1.0mm ²
5	Crank Output	Rated current 1A; power supplied by PIN 2.	1.0mm ²
6	Remote Start Input	Ground connected is active (B-)	1.0mm ²
7	Aux. Input	Connect t fuel level sensor or switch input according to function selection	1.0mm ²
8	Oil Pressure Input	Connect t Oil Pressure sensor or switch input according to function selection	1.0mm ²
9	Engine Temp. Input	Connect temperature sensor or switch input according to function selection	1.0mm ²
10	Magnetic Pickup	Connect to speed sensor, and shielded wire is recommended. The other end of speed sensor is connected to B-.	0.5mm ²
11	Generator Voltage L	Gens voltage Input, AC30-360V.	
12	Generator Voltage N		1.0mm ²
13	Load CT Secondary I* (in)	Current Transformer Secondary Rated 5A.	1.5mm ²
14	Load CT Secondary I (out)		1.5mm ²
15	Aux. Ouput1	Rated current 1A; power supplied by PIN 2.	1.0mm ²
16	Aux. Ouput2	Rated current 1A; power supplied by PIN 2.	1.0mm ²
17	Aux. Ouput3	Rated current 1A; power supplied by PIN 2.	1.0mm ²

◆ **Typical Wiring Diagram**

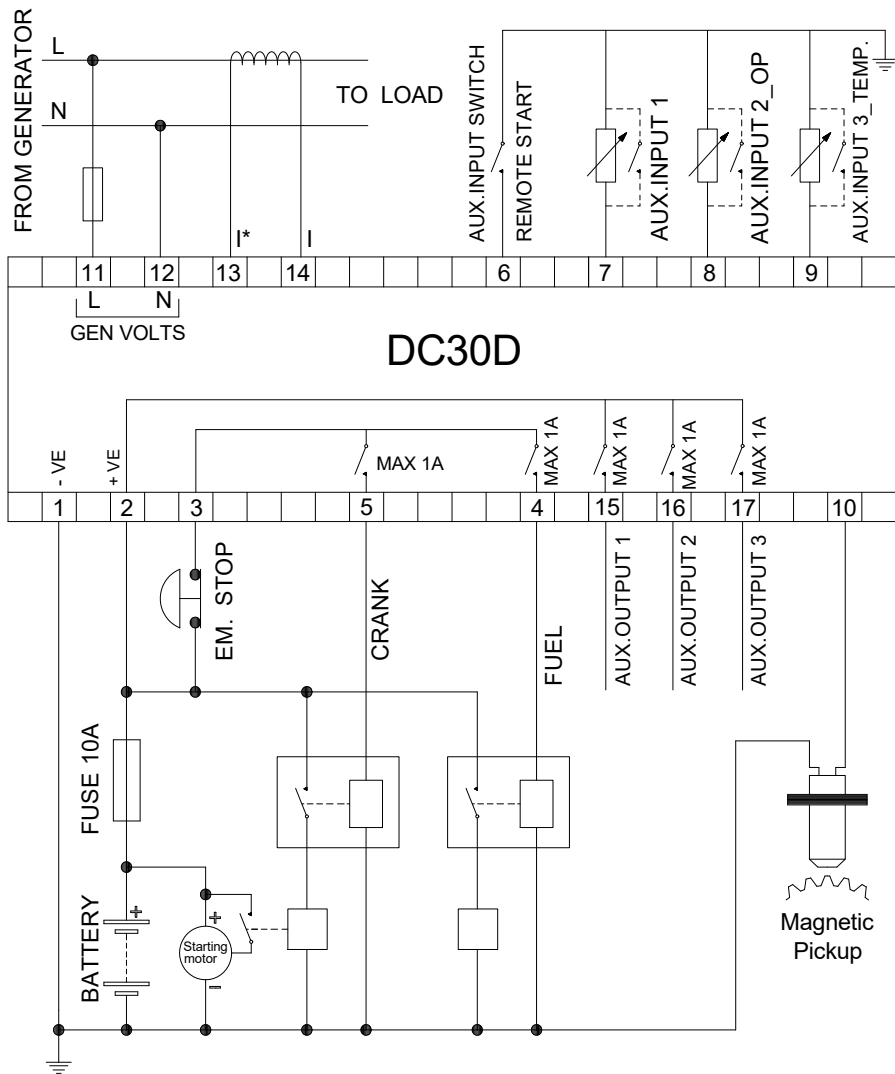

⚠ Note: Please don't move battery during running status or it may cause the controller broken!

⚠ WARNING: When generator is on-load, C. T. secondary must not be open circuit, Otherwise, the high voltage generated will pose a danger to personal safety.

7. Installation instruction

- ◆ The controller should be installed by four accessories and screw.
- ◆ Panel Cutout: W78mm*H66mm.



Note: If the controller is installed directly in the genset shell or other fluctuated equipment, the rubber pad must be installed.

◆ Battery Voltage Input

DC30D controller is suitable for 98-18 VDC battery voltage. Battery negative must be reliably connected to the enclosure of the engine. The controller power supply B+ and B- must be connected to battery positive and negative, and the wire size must not be less than 1.5mm².



NOTE:

In case of floating charger connect charger output to battery positive and negative directly, then, connect battery positive and negative poles to controller positive and negative power supply

◆ AC current input

Current transformer with rated secondary current 62.5mA must be externally connected to the controller current input.



WARNING:When generator is on-load, C. T. secondary must not be open circuit, Otherwise, the high voltage generated will pose a danger to personal safety.

◆ Withstanding voltage test



If withstanding voltage test is conducted after the controller has already been installed onto the control panel, please unplug all controller terminal connections in order to prevent high voltage from damaging it.

8. Panel and display



◆ Panel Operation



◆ Key Function Description

Button	Name	Main function
	Stop Reset Revert	<ul style="list-style-type: none"> ◆ Can stop generator under manual/auto mode. ◆ Can reset shutdown alarm. ◆ During stop procession, pressing this key again can stop generator immediately. ◆ Pressing this key can cancel the setting and back to upper class under edition. ◆ Under the setting mode with checking data, the data can be saved and system will exit after pressing. ◆ In standby mode, press the button for more than 3 seconds to check the alarm records under stop mode.
	Manual Start Decrease	<ul style="list-style-type: none"> ◆ Start the genset. ◆ Under edition mode, to decrease the numbers. ◆ Under records mode, pressing this key to change the page.
	Auto Increase	<ul style="list-style-type: none"> ◆ Pressing this key will set the module into auto mode. ◆ Under edition mode, to increase the numbers. ◆ Under records mode, pressing this key to change the page.
	Page change Confirm	<ul style="list-style-type: none"> ◆ Page change. ◆ Confirm the change under edition mode. ◆ In standby state, press for 3 seconds to enter the parameter setting mode. ◆ Choose alarm records under records checking mode.
	Setting Mode	<ul style="list-style-type: none"> ◆ Pressing "Page" and "Stop" simultaneously to come into setting mode.









◆ Engine flywheel teeth automatic adjustment

- 1) Crank disconnect must be set to "RPM/Frequency" or "RPM/Frequency/Oil Pressure".
- 2) In manual mode, Start the generator set.
- 3) At the same time, press  and  for more than 0.5 seconds, the controller will automatically calculate and save the number of flywheel teeth according to the generation frequency and generator poles.
- 4) After calculating and saving the number of flywheel teeth successfully, the controller shows: "Flywheel xxx teeth,saved successfully!"

◆ Alarm records checking

DC30D controller can save three group of alarm records which contains the alarm record data includes detailed data such as alarm time, generator parameters, engine parameters, etc.

How to check the alarm records:

- 1) Press the button  for more than 3 seconds to check the alarm records under stop mode.
- 2) In the history alarm list browsing interface, press  to move up the cursor, and press  to move down the cursor to choose the record you need. Press  to confirm the record and come into history records checking page.
- 3) Press  or  to change the alarm record data. Press  to return to the history alarm list browsing interface.
- 4) In the history alarm list browsing interface, press  to exit.

Control and operation instruction

◆ Manual Start

In stop mode turn the starter key from OFF to ON position to power on the controller, then change the starter key position to START to begin cranking; after the engine fires, release the starter key (crank disconnect condition is gen frequency > 14.0Hz), then the controller can monitor and display the relevant parameters of the generator set in real time.

◆ Manual stop

Under any circumstances, if starter key is turned from ON to OFF position, it will lead to shutdown.



Please note before manually start:

- 1) Please make sure if the connection is right and meet requests.
- 2) There is fuse in the DC power of controller and make sure if the battery + and - are connected rightly.
- 3) Please make sure if all the parameters are right and the oil pressure indicators are in normal light.

4) Please take appropriate measurement so that the genset shall be stopped under emergency.

5) Manual start mode:

Press the "STOP"  to ensure the stop gear before starting. Press "START"



start gear indicator light on, at this time will detect the normal connection of each sensor, if the sensor is open, then report the sensor open alarm, if normal, then execute the start-up process of the unit. When the unit is running normally, press the

"STOP"  and the controller will perform the parking process in the following sequence:

Manual start and stop process:

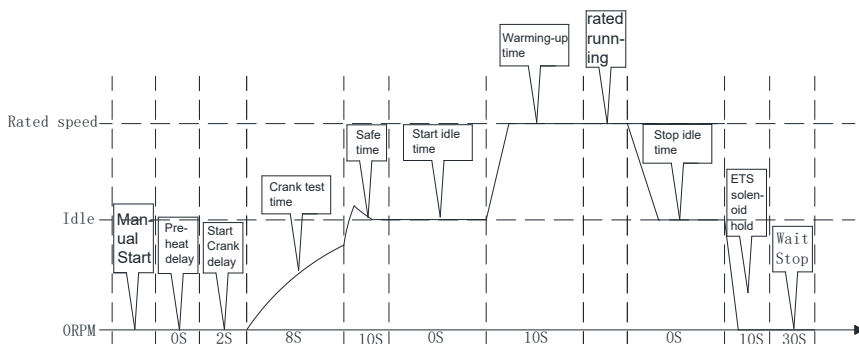

6) After the manual start is successful, pressing the "automatic key" can be converted into an automatic file. The specific working time is as follows:

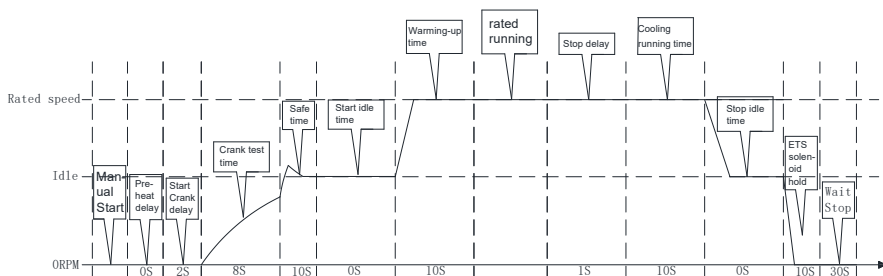

7) Automatic starting mode:

Press the "STOP"  to ensure the stop gear before starting. Press "AUTO"



automatic gear indicator light on, at this time will wait for the remote start signal to be valid, the unit will execute the start process in the following sequence. When the unit enters the normal rated operation, the power generation closing relay will output and switch to the power supply of the generating unit.

The controller will detect the remote start signal in real time. When the remote start signal fails, the " Stop delay" will be executed. After the completion of the stop delay, the engine high-speed " Cooling time" and the subsequent shutdown process

will be executed.

Auto start and stop process:

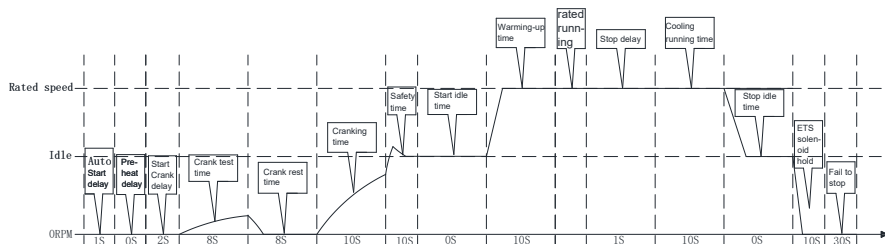

8) Notices in Starting Process

Note 1: During the Cranking time, the controller automatically detects the speed signal, frequency signal and oil pressure value (according to the parameter setting) to reach the judgment condition of successful start, then the judgment is that the start is successful and the motor relay is closed.

Note 2: Within the safety delay, only respond to emergency stop, immediate stop, over speed, over frequency, other alarms are not responded to.

Note 3: No response to alarm and warning of underspeed, low frequency, under voltage, over current during start idle time.

Note 4: No response to low frequency, under voltage, over current and over power is required when entering the Warming-up time.

Note 5: After entering rated operation, the Gens load relay output.

Note 6: In the process of shutdown, if the remote starting signal is restored to be valid within the "Cooling time", the rated operation will be entered again.

Note 7: If the stop key is pressed again during idle time, the idle time will be cancelled and the stop operation will be executed directly.

Warnings and Shutdown Alarms

◆ Warnings

Notes: Warning is a non-serious failure state, which will not harm the gensets system for the time being. It only reminds operators to pay attention to the situation that does not meet the requirements and solve it in time to ensure the continuous operation of the system. When the warning occurs, the gensets does not stop. Once the fault is removed, the warning is automatically canceled.

Low Fuel Level Sensor Warning

When the controller detects that the fuel level is lower than "Low fuel level warning", Then start warning delay and the duration (Normal alarm delay) have not returned to normal, the warning of the engine low fuel level sensor is reported. "ALARM" lights on, without stopping the engine, and displays "Low FL sensor" on the LCD screen.

Low Fuel Level Switch Warning

When the controller detects that the Low fuel level warning switch input is valid to the ground, Then start warning delay and the duration (Normal alarm delay) have not returned to normal, the warning of Low fuel level switch is reported. "**ALARM**" lights on, without stopping the engine, and displays "**Low FL switch**" on the LCD screen.

External Instant Warning

When the controller detects the validity of the "instant alarm switch input" at the switch input port, Then start warning delay and the duration (Normal alarm delay) have not returned to normal, the warning of the External instant warning is reported. "**ALARM**" lights on, without stopping the engine, and displays "**Instant warn**" on the LCD screen.

Fuel Level Sensor Opened Warning

When the safety delay is over, the controller detects that the Fuel level sensor is disconnected, Then start warning delay and the duration (Normal alarm delay) have not returned to normal, the warning of the fuel level sensor opened is reported. "**ALARM**" lights on, without stopping the engine, and displays "**FL sensor open**" on the LCD screen.

Maintenance expiration warning

When the action after the primary maintenance expired set as "warning", When the countdown to maintenance is detected as "0", Then start warning delay and the duration (Normal alarm delay) have not returned to normal, the warning of Maintenance expiration is reported. "**ALARM**" lights on, without stopping the engine, and displays "**Maintain end**" on the LCD screen.

High Battery Voltage Warning

When the controller detects that the battery voltage is higher than "**Over battery voltage warning**", Then start warning delay and the duration (Normal alarm delay) have not returned to normal, the warning of High Battery Voltage is reported. "**ALARM**" lights on, without stopping the engine, and displays "**Over BATT volt**" on the LCD screen.

Under Battery Voltage Warning

When the controller detects that the battery voltage is lower than "**Under battery voltage warning**", Then start warning delay and the duration (Normal alarm delay) have not returned to normal, the warning of Under Battery Voltage is reported. "**ALARM**" lights on, without stopping the engine, and displays "**Under BATT volt**" on the LCD screen.

◆ Starting fault

Fail to Start

If the number of cranks exceeds the predetermined number of cranks, the failure of start-up will be reported if the start-up of the generating unit is still unsuccessful. "**ALARM**" lights on, without stopping the engine, and displays "**Crank failure**" on the LCD screen.

◆ Shutdown Alarms



Warning: After the Shutdown Alarm occurs, the system will be locked immediately and the generator set will be stopped. Only after troubleshooting, press



key to clear the alarm, can it be re-operated.



Notes: When the shutdown alarm failure occurs, the "**ALARM**" lights flicker and the generator unit automatically stops.

Over Speed Alarm

When the controller detects that the engine speed is higher than "**Over speed alarm**", Then start alarm delay and the duration (Emergency delay) have not returned to normal, the alarm of over speed is reported. "**ALARM**" lights flicker, Generator stops running, and displays "**Over Speed**" on the LCD screen.

Under Speed Alarm

When the controller detects that the engine speed is under than "**Under speed alarm**", Then start alarm delay and the duration (Normal alarm delay) have not returned to normal, the alarm of under speed is reported. "**ALARM**" lights flicker, Generator stops running, and displays "**Under Speed**" on the LCD screen.

Oil Pressure Sensor Opened Alarm

When the safety delay is over, the controller detects that the Oil Pressure Sensor is disconnected, Then start alarm delay and the duration (Normal alarm delay) have not returned to normal, the alarm of the Oil Pressure Sensor opened is reported. "**ALARM**" lights flicker, Generator stops running, and displays "**OP sensor open**" on the LCD screen.

Temperature Sensor Opened Alarm

When the safety delay is over, the controller detects that the Temperature Sensor is disconnected, Then start alarm delay and the duration (Normal alarm delay) have not returned to normal, the alarm of the Temperature Sensor opened is reported. "**ALARM**" lights flicker, Generator stops running, and displays "**WT sensor open**" on the LCD screen.

Fuel Level Sensor Opened Alarm

When the safety delay is over, the controller detects that the Fuel Level Sensor is disconnected, Then start alarm delay and the duration (Normal alarm delay) have not returned to normal, the alarm of the Fuel Level Sensor opened is reported. "**ALARM**" lights flicker, Generator stops running, and displays "**FL sensor open**" on the LCD screen.

Low Oil Pressure Sensor Alarm

When the controller detects that the engine Oil Pressure is lower than "**Low oil pressure alarm**", Then start alarm delay and the duration (Normal alarm delay) have

not returned to normal, the alarm of low Oil Pressure is reported. "**ALARM**" lights flicker, Generator stops running, and displays "**Low OP sensor**" on the LCD screen.

High Temperature Sensor Alarm

When the controller detects that the engine Temperatur is higher than "**High temperature alarm**", Then start alarm delay and the duration (Normal alarm delay) have not returned to normal, the alarm of High Temperature is reported. "**ALARM**" lights flicker, Generator stops running, and displays "**High WT sensor**" on the LCD screen.

High Temperature Switch Alarm

When the controller detects that the High temperature alarm switch input is valid to the ground, Then start alarm delay and the duration (Normal alarm delay) have not returned to normal, the alarm of High Temperature Switch is reported. "**ALARM**" lights flicker, Generator stops running, and displays "**High WT switch**" on the LCD screen.

Low Fuel Level Switch Alarm

When the controller detects that the Low fuel level alarm switch input is valid to the ground, Then start alarm delay and the duration (Normal alarm delay) have not returned to normal, the alarm of Low fuel level switch is reported. "**ALARM**" lights flicker, Generator stops running, and displays "**Low FL switch**" on the LCD screen.

Oil Pressure Sensor Opened Warning

When the safety delay is over, the controller detects that the Oil Pressure sensor is disconnected, Then start alarm delay and the duration (Normal alarm delay) have not returned to normal, the alarm of the Oil Pressure sensor opened is reported. "**ALARM**" lights flicker, Generator stops running, and displays "**OP sensor open**" on the LCD screen.

Temperature Sensor Opened Warning

When the safety delay is over, the controller detects that the Temperature sensor is disconnected, Then start alarm delay and the duration (Normal alarm delay) have not returned to normal, the alarm of the Temperature sensor opened is reported. "**ALARM**" lights on flicker, Generator stops running, and displays "**WT sensor open**" on the LCD screen.

External Instant Alarm

When the controller detects that the External instant alarm input input is valid to the ground, Then start alarm delay and the duration (Normal alarm delay) have not returned to normal, the alarm of External instant input is reported. "**ALARM**" lights flicker, Generator stops running, and displays "**Instant alarm**" on the LCD screen.

Over Frequency Alarm

When the controller detects that the generator frequency is higher than "**Over freq alarm**", Then start alarm delay and the duration (Emergency delay) have not returned

to normal, the alarm of Over Frequency is reported. "**ALARM**" lights flicker, Generator stops running, and displays "**Over frequency**" on the LCD screen.

Under Frequency Alarm

When the controller detects that the generator frequency is lower than "Under speed alarm", Then start alarm delay and the duration (Normal alarm delay) have not returned to normal, the alarm of Under Frequency is reported. "**ALARM**" lights flicker, Generator stops running, and displays "**Under frequency**" on the LCD screen.

Over Voltage Alarm

When the controller detects that the voltage of the generator is higher than "Over voltage alarm", Then start alarm delay and the duration (Gens Abnormal Delay) have not returned to normal, the alarm of Over Voltage is reported. "**ALARM**" lights flicker, Generator stops running, and displays "**Over Voltage**" on the LCD screen.

Under Voltage Alarm

When the controller detects that the voltage of the generator is lower than "Under voltage alarm", Then start alarm delay and the duration (Gens Abnormal Delay) have not returned to normal, the alarm of Under Voltage is reported. "**ALARM**" lights flicker, Generator stops running, and displays "**under Voltage**" on the LCD screen.

Over Current Alarm

When the controller detects that the Current of the generator is higher than "Current over-load alarm", Then start alarm delay and the duration (Over current delay) have not returned to normal, the alarm of Over Current is reported. "**ALARM**" lights flicker, Generator stops running, and displays "**Over Current**" on the LCD screen.

Maintenance Expiration Alarm

When the action after the primary maintenance expired set as "alarm", When the countdown to maintenance is detected as "0", Then start warning delay and the duration (Normal alarm delay) have not returned to normal, the warning of Maintenance expiration is reported. "**ALARM**" lights on, Generator stops running, and displays "**Maintain end**" on the LCD screen.

Low Water Level Switch Alarm

When the controller detects that the Low water level alarm switch input is valid to the ground, Then start alarm delay and the duration (Normal alarm delay) have not returned to normal, the alarm of Low water level switch is reported. "**ALARM**" lights flicker, Generator stops running, and displays "**Low Water Level**" on the LCD screen.

Emergency Stop Alarm

When the controller detects that the input voltage of PIN 3 is less than 2V, Then start alarm delay and the duration (Emergency delay) have not returned to normal, the alarm of Emergency Stop is reported. "**ALARM**" lights flicker, Generator stops running, and displays "**Emergency stop**" on the LCD screen.

Stop Failure With Speed Alarm

When the controller detects that the speed is not "0" after the execution of the shutdown, the alarm of stop failure is reported. "ALARM" lights flicker, and displays "Stop fail-RPM" on the LCD screen.

Stop Failure With Frequency Alarm



When the controller detects that the frequency is not "0" after the execution of the shutdown, the alarm of stop failure is reported. "ALARM" lights flicker, and displays "Stop fail-Hz" on the LCD screen.

Stop Failure With Pressure Alarm



When the controller detects that the Oil Pressure is not "0" after the execution of the shutdown, the alarm of stop failure is reported. "ALARM" lights flicker, and displays "Stop fail-OP" on the LCD screen.



9. Parameter setting

◆ Please set the parameters according to below steps:

1) In the stop mode, please  and  simultaneously, then loose  so that you can come to configuration mode.

2) Select the "Set Parameters" menu and press , then you can come to enter password interface, the default password is "07623".

3) Under the parameter browsing interface, press  to shift up the parameters, press  to shift down the parameters, press  to get into parameter changing page.

4) Under the parameter modification interface, Press  to add number 1, press  to reduce number 1, press  to turn the digit into right and done.

5) Under the parameter modification interface, Press  to cancel parameter modification and return to parameter browsing interface.

6) Under the parameter browsing interface, Press  to save the parameters and exit from edition page.

 Revert back to default: input password "97011" when coming into parameters setting, then all the parameters can be set as defaults.

 **Note: the data can not be saved if the user didn't press STOP to confirm the setting.**

◆ Parameter list.

1) Basic setting

No	Parameter	Range (default)	Notes
0	Language	English 简体中文	Language option.

1	Gens poles	2/4/6/8(4)	When the flywheel teeth is set as 0, the RPM will be resulted by frequency. Pole 2: 50Hz---3000RPM. Pole 4: 50Hz---1500RPM. Pole 6: 50Hz---1000RPM. Pole 8: 50Hz---750RPM
2	Gens AC system	Disable 1 phase 2 wire 2 phase 3 wire 3 phase 3 wire 3 phase 4 wire 1P/3P	Gens phases: No gens parameters can be displayed if setting as disable, which is applied to water pump genset. 1P1W: Power*1. 2P3W: Power*2. 3P3W: Power*2. 3P4W: Power*3. 1P/3P: Input ≤ 300V: Power=voltage*current, Current=phase current; Input > 300V: Power=voltage/1.732*current *3, Current=phase current; Rated phase current=Rated current/3.
3	CT rate	5-6000A/5A (500A/5A)	Used for setting genset CT primary current, secondary rated current 5A.
4	Rated frequency	40.0-80.0Hz(50.0Hz)	Calculate the alarm value.
5	Rated voltage	80-360V(230V)	Calculate the alarm value.
6	Rated current	5-6000A(500A)	Calculate the alarm value.
7	Rated battery voltage	8.0-36.0V(24.0V)	Calculate the alarm value. One battery gens should be set as 12V, two batteries gens should be set as 24V.
8	Rated RPM	500-4500RPM(1500)	Calculate the alarm value.
9	Flywheel teeth	0-300(0)	If the setting is 0, (RPM sensor Disabled), then RPM is resulted by Hz.
10	Pressure/Temperature unit	°C/KPA °C/BAR °C/PSI F/KPA F/BAR F/PSI	Unit display.
11	Power on Mode	STOP Auto Auto save	The mode of Controller after Power-on. Note: Auto save function can not record the mode with manual.
12	Manual crank times	1-30 (1 time)	Crank times under mode and test mode.
13	Auto start crank times	1-30 (3 times)	Crank times under auto mode.
14	E.T.S. hold times	1-10(2 times)	The max E.T.S. hold on power shall be canceled once stop success under auto mode . the output interval time is " Fail to stop ".

15	Crank disconnect	RPM Hz Oil pressure(delay) RPM/Frequency RPM/Oil Pressure Frequency/Oil Pressure RPM/Frequency/Oil press.	1.If there is no oil pressure sensor, please don't choose it. 2.Oil pressure switch input is not the crank condition 3.Please check if the running status, stop condition are according with crank condition. 4.Means either of the conditions can be acceptable as crank condition. But all of them should be meet together to regard as stop condition.
16	Frequency disconnect	0-200% (28%)	Rated frequency multiplying by this value is regarded as crank success condition. When the gens frequency is over the condition value, then system regards it as crank success.
17	Oil pressure disconnect	0-400kpa (200kpa)	When the engine oil pressure is over the condition value, then system regards it as crank success, motor escaped.
18	RPM disconnect	0-200% (24%)	Rated RPM multiplying by this value is regarded as crank success condition. When the RPM is over the condition value, then system regards it as crank success, motor escaped.
19	Temperature for Fan open	20—200℃ (75 ℃)	Used for controlling radiator: when the temperature reaches the set temperature, then the radiator is opened.
20	Temperature for Fan close	20—200℃ (60 ℃)	Used for controlling radiator: when the temperature is lower than the set temperature, then the radiator is closed.
21	Maintenance countdown	0-5000h (500h)	When it is set as 5000, then this function is disabled.
22	Maintenance expire	Warning/Alarm and stop	The action after the primary maintenance expired.
23	User password	00000-65535 (07623)	Change the password.

2) Delay time setting

NO	Parameter	Range(default)	Notes
1	Start delay	0-6500.0s (1.0s)	The time during the genset starts after the remote start signal is valid.
2	Stop delay	0-6500.0s (1.0s)	The time during the genset stop after the remote start signal is invalid.
3	Preheat time	0-6500.0s (0.0s)	The time needed to be preheat before the starter on power.
4	Cranking time	3.0-60.0s (8.0s)	The time when the starter is on power.
5	Crank rest time	3.0-60.0s (10.0s)	If crank failure, the waiting time before the second test time.
6	Oil pressure	0-20.0s (0.0s)	When the crank condition contains oil pressure,

	disconnect delay		if the oil pressure is higher than the preset value and continue for few seconds, then it is regarded as crank success.
7	Safety delay	1.0-60.0s(10.0s)	Low oil pressure, high temperature, under speed, under frequency, under voltage, charge failure are all invalid during this time except for emergency stop ,over speed, over freq.
8	Start idle time	0-3600.0s(0.0s)	Idle running time when crank successfully.
9	Warming-up time	0-3600.0s(10.0s)	The time needed for loading.
10	Cooling time	0-3600.0s(10.0s)	After unloading, the time of cooling down by radiator before stop. During the delay, if the remote start signal is valid, then genset will come into rated running.
11	Stop idle time	0-3600.0s(0.0s)	Idle-speed running time.
12	E.T.S. hold time	0-600.0s(20.0s)	Stop solenoid on power time.
13	Fail to stop	5-180.0s(0.0s)	If the RPM is 0 during the stop failure time, then the stop failure time is no needed.
14	Emergency delay	0-10.0s(1.5s)	Emergency and over frequency alarm delay.
15	Normal alarm delay	2.0-20.0s(5.0s)	The alarm delay except for emergency stop and over frequency
16	Gens Abnormal Delay	2.0-20.0s(10.0s)	It is used for alarm delay of generator with high or low voltage.
17	Choke close delay	0-200.0s(3.0s)	Choke close delay.
18	Over current delay	0—3600.0s (60.0s)	When the loading current is higher than the preset value, it is regarded as over current.
19	Fuel output delay	1.0-60.0s(2.0s)	The output time of fuel valve relay before crank.

3)Engine Alarm setting

NO	Parameter	Range (defaults)	Notes
1	Over speed alarm	0-200% (114%)	Rated RPM multiplying by this value is regarded as over speed alarm value.When the RPM is higher than the alarm value and comes into over speed delay but still higher(emergency faults delay), then over speed alarms. if the value is set as 200, then the over speed alarm is disabled.
2	Under speed alarm	0-200% (80%)	Rated RPM multiplying by this value is regarded as under speed alarm value.When the RPM is lower than the alarm value and comes into under speed delay but still lower (normal faults delay), then under speed alarms. if the value is set as 0, then the under speed alarm is disabled.
3	Low oil pressure alarm	0-999kpa (103kpa)	When the oil pressure is lower than the alarm value and comes into low oil pressure delay but still lower (normal faults delay), then low oil pressure alarms. If the value is set as 0, then the under speed alarm is disabled.

4	High temperature alarm	20-200°C (98 °C)	When the temperature is higher than the alarm value and comes into high temperature delay but still higher (normal faults delay), then high temperature alarms. If the value is set as 200, then the high temperature alarm is disabled.
5	Low fuel level warning	0-100% (10%)	When the fuel level is lower than the value and comes into low fuel level warning delay but still lower (normal warning delay), then low fuel level warns. If it is higher than the value then warning clears. If the value is set as 0, then the low fuel level warning is disabled.
6	Over battery voltage warning	0-200% (135%)	Rated battery voltage multiplying by this value is regarded as over battery voltage warning value. When the battery input is higher than the warning value and comes into over battery voltage delay but still higher (normal faults delay), then over battery voltage warns. if the value is set as 200, then the over battery voltage is disabled.
7	Under battery voltage warning	0-200% (67%)	Rated battery voltage multiplying by this value is regarded as under battery voltage warn value. When the battery input is lower than the warning value and comes into under battery voltage delay but still lower (normal faults delay), then under battery voltage warns. if the value is set as 0, then the under battery voltage is disabled.

4) Generator alarm parameters

NO	Parameter	Range(defaults)	Notes
1	Over freq alarm	0-200% (114%)	Rated frequency multiplying by this value is regarded as under over frequency alarm value. When the Freq is higher than the value and comes into over freq delay but still higher (emergency faults delay), then over frequency alarms. If the value is set as 200, then the alarm is disabled.
2	Under freq alarm	0-200% (80%)	Rated frequency multiplying by this value is regarded as under frequency alarm value. When the Freq is lower than the value and comes into under freq delay but still lower (normal faults delay), then under frequency alarms. If the value is set as 0, then the alarm is disabled.
3	Over voltage alarm	0-200% (120%)	Rated voltage multiplying by this value is regarded as over voltage alarm value. When the voltage is higher than the value and comes into over voltage delay but still higher (normal faults delay), then over voltage alarms. If the value is set as 200, then the alarm is disabled.
4	Under voltage	0-200% (80%)	Rated voltage multiplying by this value is regarded as under voltage alarm value. When the voltage is lower

	alarm		than the value and comes into under voltage delay but still lower (normal faults delay), then under voltage alarms.If the value is set as 0, then the alarm is disabled.
5	Current over-load alarm	0-200%(100%)	Rated current multiplying by this value is regarded as over current alarm value. When the current is higher than the value and comes into over current delay but still higher (over current faults delay), then over current alarms.If the value is set as 200, then the alarm is disabled.

5)Output/input setting

NO	Parameters	Range(defaults)	Notes
1	AUX. OUTPUT 1 (Functional of PIN 15)	0-11(7. Idle speed control)	0. Disable. 1. Public warning output: when there is any warning output. 2. Public alarm output: when there is any alarm output, alarm locks till revert back. 3. Preheat mode 1: preheat before start.
2	AUX. OUTPUT 2 (Functional of PIN 16)	0-11 (12. E.S.T. hold)	4. Fuel output: output once gens starts and off till stable. 5. Crank output: output once cranking.
3	AUX. OUTPUT 3 (Functional of PIN 17)	0-11(2.Public alarm output)	6. Choke control: choke will be started after crank success and off after delay. 7. Idle speed control: used for speed controller, there is no output under idle but output under high speed. 8. Gens load: there is continuous output once the conditions can be meet, which can control the switch with load. 9. High speed control: The output is valid after idle delay is completed, and the output is invalid after high-speed heat dissipation. 10. Fan Control: used to control radiator electrical fan. there is output when the preset temperature is higher than " Temperature for Fan open " and no output when the preset temperature is lower than " Temperature for Fan close ". 11. E.S.T. hold: shutdown output, it is used for gens with stop solenoid. when the setting value of shutdown delay is over, then it is off. 12. Rated running: there is output under rated running.
4	AUX. INPUT SWITCH (Functional of PIN 6)	0-10(1. Remote start)	0. Disable. 1. Remote start switch input. 2. Low oil pressure alarm switch input. 3. High temperature alarm switch input.

			<p>4.Low water level alarm switch input. 5.Low fuel level warning switch input. 6.Low fuel level alarm switch input. 7.External instant warning input. 8.External instant alarm input. 9.High temperature cooling and Stop Input : When the signal is valid and the generator is in normal operation, if there is a high temperature alarm, the controller will stop the generator after high-speed heat dissipation delay; when the signal is invalid, if there is a high temperature alarm, the controller will stop directly. 10.Reserve for switching input</p>
5	<p>AUX. INPUT 1 (Functional of PIN 7)</p>	<p>0-21 (0. Disable)</p>	<p>0.Disable. 1.Remote start switch input. 2.Low oil pressure alarm switch input. 3.High temperature alarm switch input. 4.Low water level alarm switch input. 5.Low fuel level warning switch input. 6.Low fuel level alarm switch input. 7.External instant warning input. 8.External instant alarm input. 9.High Temperature cooling and Stop Input : When the signal is valid and the generator is in normal operation, if there is a high temperature alarm, the controller will stop the generator after high-speed heat dissipation delay; when the signal is invalid, if there is a high temperature alarm, the controller will stop directly. 10.Reserve for switching input 11. Self-define fuel level sensor 12.Fuel level sensor 0-100 Ω 13.Fuel level sensor 100-0 Ω 14.Fuel level sensor 0-107 Ω 15.Fuel level sensor 107-0 Ω 16.Fuel level sensor 0-180 Ω 17.Fuel level sensor 180-0 Ω 18.Fuel level sensor 180-10 Ω 19.Fuel level sensor 10-180 Ω 20.Fuel level sensor 120-10 Ω 21.Fuel level sensor 10-120 Ω 22.Fuel level sensor 90-0 Ω 23.Fuel level sensor 0-90 Ω 24.Fuel level sensor 0-30 Ω</p>

			25.Fuel level sensor 73-10 Ω 26.Fuel level sensor 240-33 Ω 27.Fuel level sensor 33-100 Ω 28.Fuel level sensor 0-200 Ω 29.Fuel level sensor 200-0 Ω 30.Fuel level sensor 0-190 Ω 31.Fuel level sensor 190-0 Ω
6	AUX. INPUT 2 (Functional of PIN 8)	0-23(11. Oil pressure sensor VDO 0-10Bar)	0.Disable. 1.Remote start (on load). 2.Low oil pressure alarm switch input. 3.High temperature alarm switch input. 4.Low water level alarm switch input. 5.Low fuel level warning switch input. 6.Low fuel level alarm switch input. 7.External instant warning input. 8.External instant alarm input. 9.High Temperature cooling and Stop Input : When the signal is valid and the generator is in normal operation, if there is a high temperature alarm, the controller will stop the generator after high-speed heat dissipation delay; when the signal is invalid, if there is a high temperature alarm, the controller will stop directly. 10.Reserve for switching input 11. Self-define oil pressure sensor 12. Oil pressure sensor VDO 0-10Bar 13.Oil pressure sensor MEBAY-003B 14.Oil pressure sensor SGH 15.Oil pressure sensor SGD 16.Oil pressure sensor SGX 17.Oil pressure sensor CURTIS 18.Oil pressure sensor DATCON 10Bar 19.Oil pressure sensor VOLVO-EC 20.Oil pressure sensor 3015237 21.Oil pressure sensor WEICHA1 0-0.6MPa 22.Oil pressure sensor GENCON 0-10Bar
7	AUX. INPUT 3 (Functional of PIN 9)	0-24 (11.Temperature sensor VDO 40-120 ℃)	0.Disable. 1.Remote start (on load). 2.Low oil pressure alarm switch input. 3.High temperature alarm switch input. 4.Low water level alarm switch input. 5.Low fuel level warning switch input. 6.Low fuel level alarm switch input. 7.External instant warning input. 8.External instant alarm input.

			<p>9.High temperature shutdown disabled: When the signal is valid and the generator is in normal operation, if there is a high temperature alarm, the controller will stop the generator after high-speed heat dissipation delay; when the signal is invalid, if there is a high temperature alarm, the controller will stop directly.</p> <p>10.Reserve for switching input</p> <p>11.Self-define temperature sensor</p> <p>12. Temperature sensor VDO 40-120 °C</p> <p>13.Temperature sensor MEBAY-001B</p> <p>14.Temperature sensor SGH</p> <p>15.Temperature sensor SGD</p> <p>16.Temperature sensor SGX</p> <p>17.Temperature sensor CURTIS</p> <p>18.Temperature sensor DATCON</p> <p>19.Temperature sensor VOLVO-EC</p> <p>20.Temperature sensor 3015238</p> <p>21.Temperature sensor PT100</p> <p>22.Temperature sensor MEBAY-Mier</p> <p>23.Temperature sensor WEICHA1 40-120°C</p> <p>24.Temperature sensor GENCON 40-120°C</p>
--	--	--	--

6)LCD setting

No	Parameter	Range(defaults)	Notes
1	Start screen display	0-20.0s(5.0s)	Start screen display time,0: No-display.
2	Saving mode	5.0-6000.0s (600.0s)	LCD light will be closed automatically without any button pressed after delay.If setting as 200.0s, back light always lighted.
3	Homing display	5.0-600.0s (600.0s)	The time when the page reverts back to the home page .If setting as 600.0s:disabled.
4	LOGO delay display under standby	5.0-6000.0 (6000.0s)	Start screen will be opened without any button pressed after delay.If setting as 6000.0s: disabled.

7)Self-define curve

NO	Parameter	Notes
1	Self-define oil pressure	<i>Sensor curve can be User-defined by panel buttons, resistance and according value should be input,MAX 15 groups ,MIN 2 groups.</i>
2	Self-define temperature	
3	Self-define fuel level curve	

10.Fault finding

Symptoms	Possible Solutions
Controller no response with power	Check DC voltage. Check DC fuse. Check if the terminal 1 and 2 is with battery voltage.

Genset shutdown	<p>Check the water/cylinder temperature is too high or not;</p> <p>Check the genset AC voltage;</p> <p>Check DC fuse.</p>
Genset Emergency Stop	<p>Check the emergency stop button;</p> <p>Check that the voltage of the controller's 3 feet to the ground should be the battery voltage.</p> <p>Check the controller connection.</p>
Low oil pressure alarm	<p>Check oil pressure sensor and its wiring.</p> <p>Check the oil pressure sensor type and controller settings must be consistent;</p> <p>Check whether the low pressure sensor is normal.</p>
High temperature alarm	<p>Check temperature sensor and its wiring.</p> <p>Check the temperature sensor type and controller settings must be consistent;</p> <p>Check whether the temperature sensor is normal.</p>
Shutdown Alarm in running	<p>Check related switch and its connections according to the information on LCD; Check programmable inputs.</p>
Fail to start	<p>Check fuel return circuit and wiring.</p> <p>Check start battery.</p> <p>Consult engine manual.</p>
Starter motor does not respond	<p>Check the wiring to the starter.</p> <p>Check start battery.</p>
USB communication is abnormal	<p>Check the USB connection;</p> <p>Check whether the USB port of the computer is normal.</p> <p>Check whether the USB driver is installed.</p>